

Werkvoorbereiding lasersnijden

Naam	Rick Koelewijn
Klas	MTD3A4
Project	Koptelefoon
Datum	21-06-2017
Bijlagen	Documenten lasersnijden
Telefoonnummer	06 53 69 7882

Tekening/screenshot

Wat Wanneer Geschatte uren

Benodigd gereedschap:			
Benodigd gereedschap:	Lasersnijder	22-06-2017	2,5
Benodigd gereedschap:			
Benodigd gereedschap:			
Benodigd Materiaal:	Schuimkussen	22-06-2017	2x
Benodigd Materiaal:	MDF 4mm	22-06-2017	8x
Benodigd Materiaal:	Polystyreen	22-06-2017	2x
Totaal uren			6

Handtekening docent

Tekeningen bijlagen	Tekeningen MDF
Tekeningen bijlagen	Tekening Schuimkussen
Tekeningen bijlagen	Tekening polystyreen
Tekeningen bijlagen	

Handtekening werkplaats

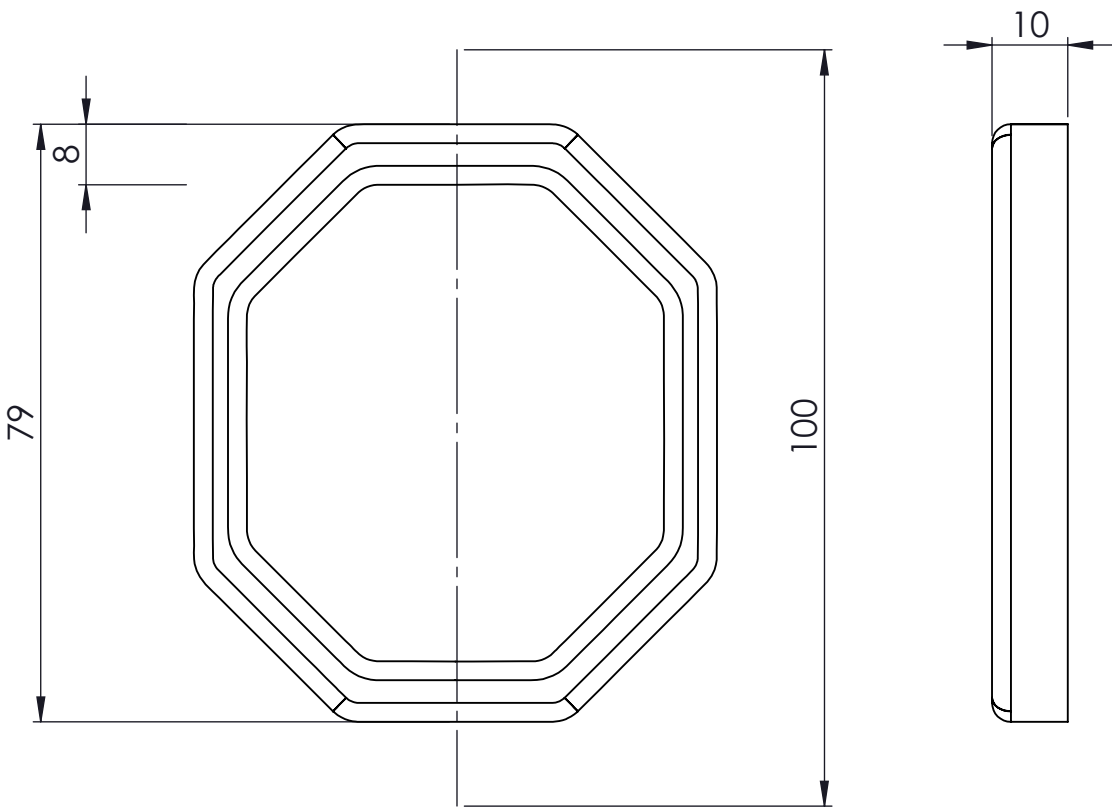
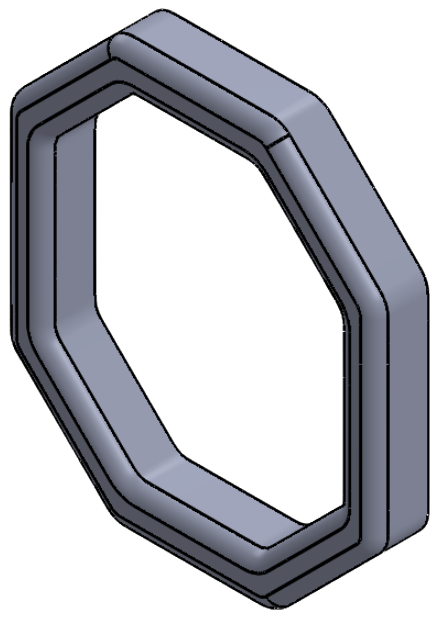
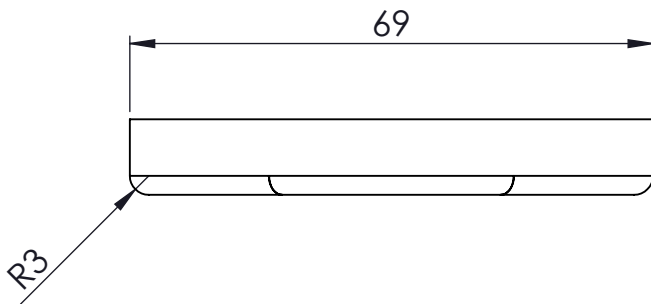

Opp. ruwheid (zie NEN 3634)	Maattoleranties NEN-ISO 2768-	MATERIAAL: Schuimkussen	Vorm- en plaatstol. (zie NEN-ISO11010)	
	SCHAAL: 1:1	GETEKEND: Rick Koelewijn	OPMERKING:	
	MAATEENHEID: mm	AFDELING: MTD3A4-IPO		
	DATUM: 22-6-2017	GEZIEN:		
SDU WORKS Educational Product. For Instructional Use Only Kussen			NUMMER: 1	A4

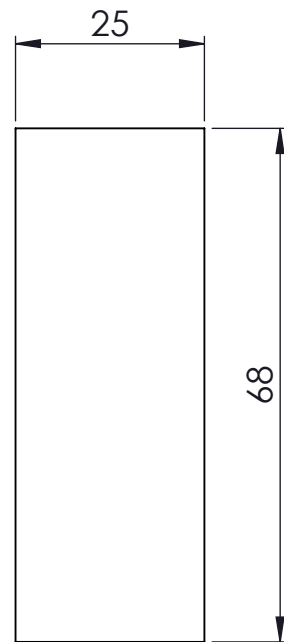
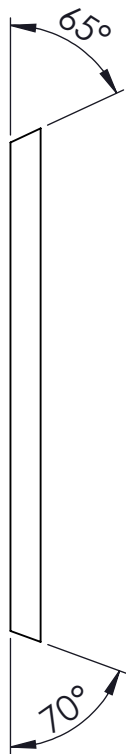
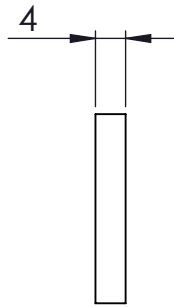

Opp. ruwheid (zie NEN 3634)	Maattoleranties NEN-ISO 2768-	MATERIAAL: MDF 4mm	Vorm- en plaatstol. (zie NEN-ISO11010)
	SCHAAL: 1:1	GETEKEND: Rick Koelewijn	OPMERKING:
	MAATEENHEID: mm	AFDELING: MTD3A4-IPO	
	DATUM: 22-6-2017	GEZIEN:	
			NUMMER: 2
Hoofdband onderdeel 1			A4

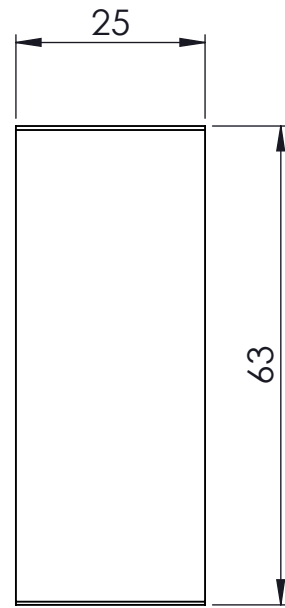
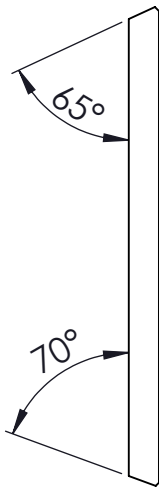
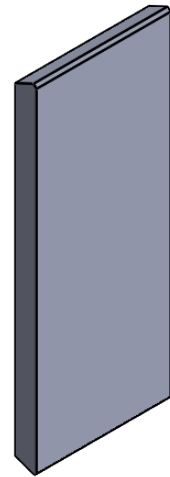
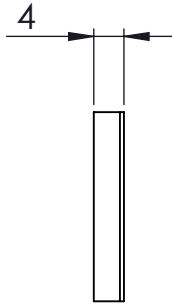

Opp. ruwheid (zie NEN 3634)	Maattoleranties NEN-ISO 2768-	MATERIAAL: MDF 4mm	Vorm- en plaatstol. (zie NEN-ISO11010)	
	SCHAAL: 1:1	GETEKEND: Rick Koelewijn	OPMERKING:	
	MAATEENHEID: mm	AFDELING: MTD3A4-IPO		
	DATUM: 22-6-2017	GEZIEN:		
SDU WORKS Educational Product. For Instructional Use Only Hoofdband onderdeel 2			NUMMER: 3	A4

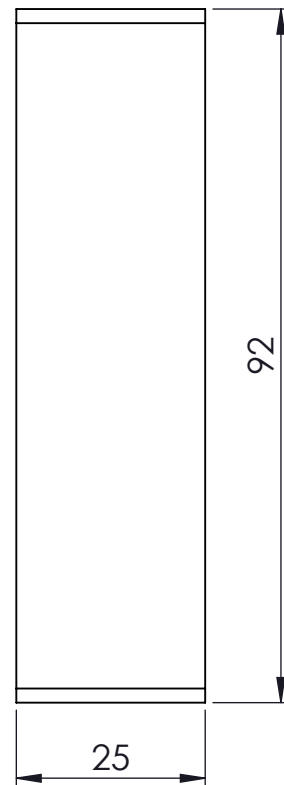
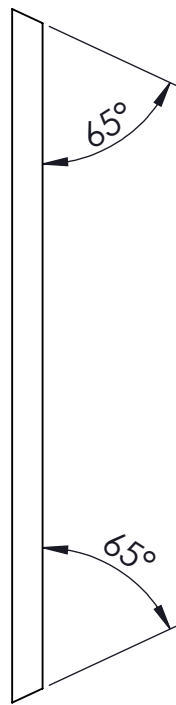
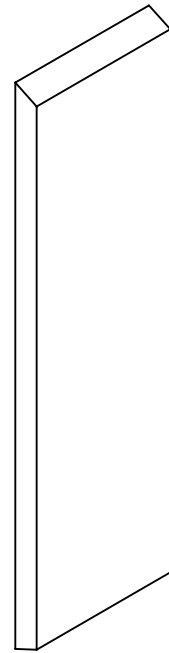
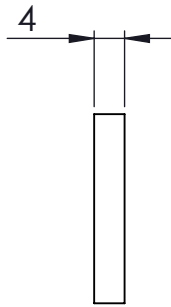

Opp. ruwheid (zie NEN 3634)	Maattoleranties NEN-ISO 2768-	MATERIAAL: MDF 4mm	Vorm- en plaatstol. (zie NEN-ISO11010)
	SCHAAL: 1:1	GETEKEND: Rick Koelewijn	OPMERKING:
	MAATEENHEID: mm	AFDELING: MTD3A4-IPO	
	DATUM: 22-6-2017	GEZIEN:	
		Hoofdband onderdeel 3	NUMMER: 4
			A4

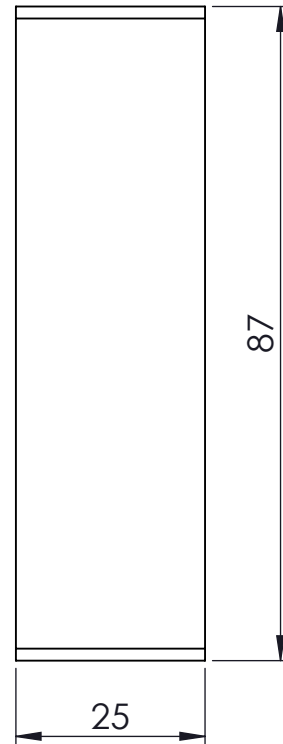
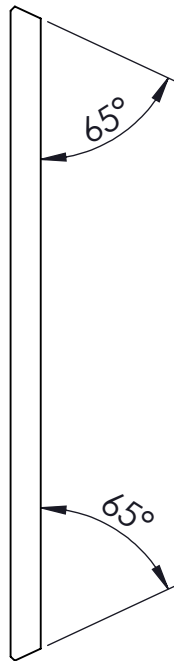
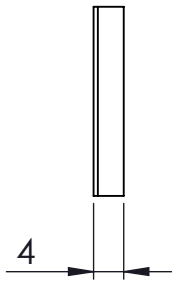

Opp. ruwheid (zie NEN 3634)	Maattoleranties NEN-ISO 2768-	MATERIAAL: MDF	Vorm- en plaatstol. (zie NEN-ISO11010)
	SCHAAL: 1:1	GETEKEND: Rick Koelewijn	OPMERKING:
	MAATEENHEID: mm	AFDELING: MTD3A4-IPO	
	DATUM: 22-6-2017	GEZIEN:	
			NUMMER: 5
Hoofdband onderdeel 4			A4

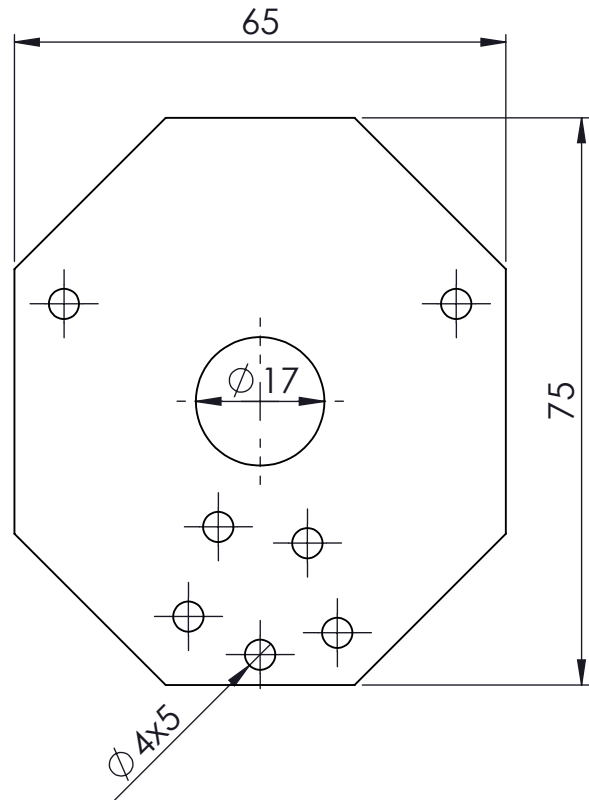
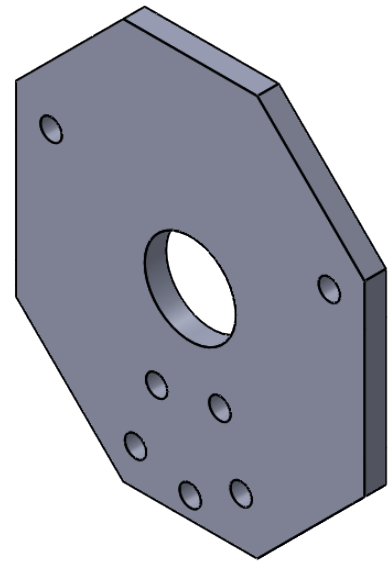
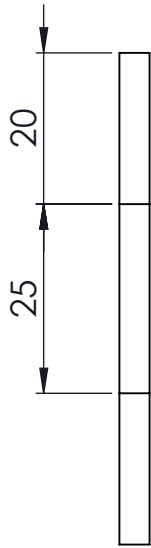

Opp. ruwheid (zie NEN 3634)	Maattoleranties NEN-ISO 2768-	MATERIAAL: MDF 4mm	Vorm- en plaatstol. (zie NEN-ISO11010)
	SCHAAL: 1:1	GETEKEND: Rick Koelewijn	OPMERKING:
	MAATEENHEID: mm	AFDELING: MTD3A4-IPO	
	DATUM: 22-6-2017	GEZIEN:	
		BENAAMING: Speaker poss. plaat	NUMMER: 6

A4

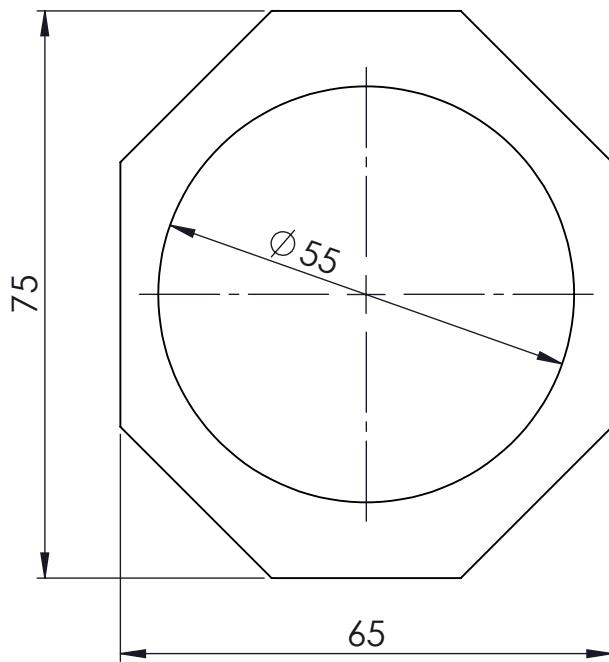
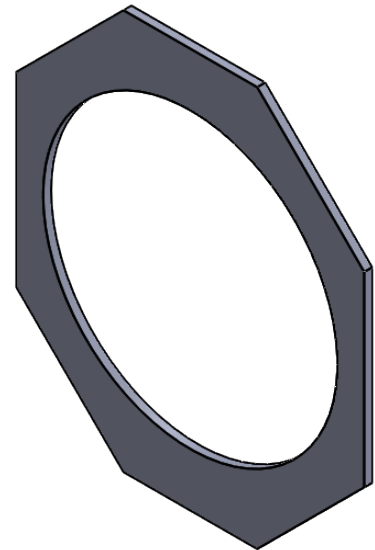
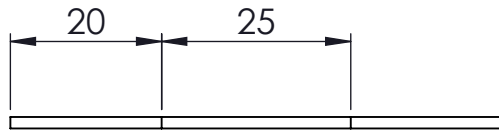

Opp. ruwheid (zie NEN 3634)	Maattoleranties NEN-ISO 2768-	MATERIAAL: Polystyreen (PS)	Vorm- en plaatstol. (zie NEN-ISO11010)	
	SCHAAL: 1:1	GETEKEND: Rick Koelewijn	OPMERKING:	
	MAATEENHEID: mm	AFDELING: MTD3A4-IPO		
	DATUM: 22-6-2017	GEZIEN:		
SDU WORKS Educational Product. For Institutional Use Only Afdekplaat			NUMMER: 7	A4